

ONKYO® SERVICE MANUAL

STEREO CASSETTE

TAPE DECK

MODEL TA-2066

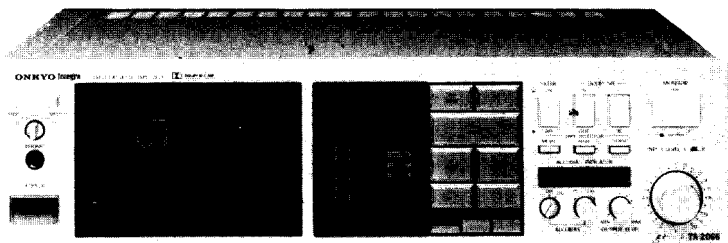

UDN, UDC, UD	120V AC, 60Hz
UGV, UG	220V AC, 50Hz
UW	120 or 220V AC, 50/60Hz
UQA, UQB	240V AC, 50Hz

SAFETY-RELATED COMPONENT WARNING!!

COMPONENTS IDENTIFIED BY MARK \triangle ON THE SCHEMATIC DIAGRAM AND IN THE PARTS LIST ARE CRITICAL FOR RISK OF FIRE AND ELECTRIC SHOCK. REPLACE THESE COMPONENTS WITH ONKYO PARTS WHOSE PARTS NUMBER AS SHOWN IN THIS MANUAL.

MAKE LEAKAGE-CURRENT OR RESISTANCE MEASUREMENTS TO DETERMINE THAT EXPOSED PARTS ARE ACCEPTABLY INSULATED FROM THE SUPPLY CIRCUIT BEFORE RETURNING THE APPLIANCE TO THE CUSTOMER.

SPECIFICATIONS

Track Format:	4 tracks, 2 channels
Erasing System:	AC erase
Tape Speed:	4.8 cm/sec. (1-7/8 i.p.s.)
Wow & Flutter:	0.035% (WRMS)
Frequency Response:	20-17,000 Hz (25-16,000 Hz \pm 3 dB) (normal position tape) 20-19,000 Hz (25-18,000 Hz \pm 3 dB) (high position tape) 20-21,000 Hz (25-20,000 Hz \pm 3 dB) (metal position tape)
Signal-to-Noise Ratio:	60 dB (Metal position tape, Dolby NR out) A noise reduction of 10 dB above 5 kHz and 5 dB at 1 kHz is possible with Dolby B NR. A noise reduction of 20 dB at 5 kHz is possible with Dolby C NR.
Input Jacks:	Line IN: 2 Minimum input level: 50 mV Input impedance: 50 kohms



Outputs:	Line OUT: 2 Std output level: 1100 mV (0 dB) Opt load impedance: over 50 kohms
	Headphones: Opt impedance: 8 — 200 ohms
Motors:	Direct-drive motor: 1 DC motor: 2
Heads:	Rec/pb head: Special Hard Permalloy Erase head: Ferrite
Semiconductors:	TR: 87 Diodes: 42 IC: 18 LED: 15
Power Supply:	AC120 V/60 Hz
Power Consumption:	40 watts
Dimensions:	435(W) x 112(H) x 371(D) mm (17-1/8" x 4-3/8" x 14-5/8")
Weight:	6.7 kg. (14.8 lbs.)

Specifications and external appearance are subject to change without notice because of product improvements.

SERVICE PROCEDURES

1. Replacing the lamps

This unit used the lamps listed below.

Circuit No.	Parts No.	Description
PL-101	210149	PL14V 0.06A W3.0
PL-201—205	210165	PL14V 150mA
PL-902	210165	PL14V 150mA

Caution; Before replacing the lamps, be sure to unplug the power supply cable.

2. Instruction resistance measurement

Connect the insulating-resistance tester between the plug of power supply cord and chassis.

Specifications; D model	500 V 3.3±0.33 MΩ
G/W models	500 V more than 10 MΩ

3. Replacing the Dolby ICs

Because the TA-2066 is 3-head deck, it is equipped with a 4-channel Doiby processor. Two channels are used exclusively for encoding and the other two exclusively for decoding. If there is a difference between the performance of the encode and decode sides, both Dolby B and C NR will not operate properly. To prevent this, the TA-2066 employs the HA-12038-01. The appearance is the same as the standard HA-12308 with colored markings on the top surface of the IC. When replacing the HA-12038-01, the four ICs (Q107, Q108, Q211, Q212) in the new one should all have the same color markings. If ICs with the same color markings are not available, the Q107-Q211 and Q108-Q212 colors should be matched. That is, the two encode ICs and the two decode ICs must always be of the same color although it is possible to use different colors on the encode and decode sides when necessary.

FEATURES

Newly Developed Accubias System

Onkyo's most recent Accubias system not only provides the optimum bias for any kind of cassette tape to assure flat frequency response but also lets you adjust bias to obtain other frequency response curves. The current frequency response is displayed by an easy-to-read multi-color indicator and the bias setting is preserved until the Accubias control knob is changed to a different bias setting.

Three Heads with Special Hard Permalloy For Superior Metal Tape Performance

Having three heads means you can monitor the actual recorded signal as you record instead of rewinding the tape to check your recording afterward. The 3-head system also has the advantage of making possible the use of separate record and playback gaps, each optimized for its own task. The special hard permalloy head formulation boasts the high saturation flux density and abrasion resistance needed for true metal tape compatibility.

3-Motor Silent Mechanism with DC Servo-Controlled Direct-Drive Capstan Motor

The TA-2066 uses a highly accurate servo-controlled DC motor to drive the capstan directly. This motor is completely unaffected by momentary fluctuations in voltage and load to maintain outstanding stability and precision at all times. Overall construction is simplified to maximize reliability and the vertical cassette holder further contributes to stable and accurate tape travel. As a result, wow and flutter is 0.035%, a figure that places the TA-2066 among the best cassette decks on the market today. Separate DC motors are used for the reel tables and head assembly to optimize performance and provide smooth and silent movement of the head base.

Dolby B and C Noise Reduction

Along with standard Dolby B NR, the TA-2066 also has the even more effective Dolby C NR system. Dolby C NR reduces tape background noise by 20 dB at 5 kHz, about 3 times more than Dolby B NR. In addition to its wide band noise reduction, Dolby C NR uses a sliding band technique that varies the band width of noise reduction according to the input level, thereby avoiding noise "pumping." Dolby C NR also has an anti-saturation effect to reduce the chance of tape saturation in the high range. All these features combine to eliminate the adverse effects on tape sound that other noise reduction systems can cause.

Auto Music Control System (A.M.C.S.)

The AMCS automatically locates the beginning of every song on a cassette in either the forward or the reverse direction. When AMCS FWD is pressed during the play mode, tape is rapidly wound to the beginning of the next song and the first 15 seconds (approximately) is played. Then the tape is rapidly wound forward to the beginning of the next song and about 15 seconds is played. This process continues until the PLAY button is pressed to cancel AMCS and return to normal playback. When AMCS REV is pressed during the play mode, this process is performed in the reverse direction.

FRONT PANEL FACILITIES

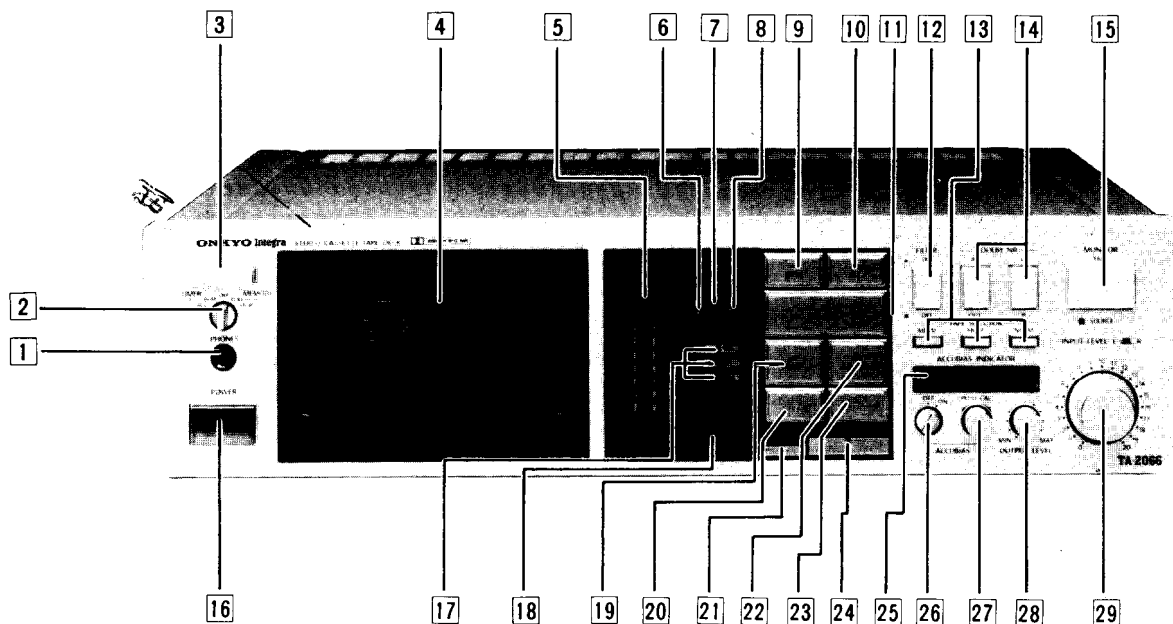

SPECIAL MODES OF OPERATION

Using the Accubias System

A. To obtain flat frequency response:

1. Insert a cassette.
2. Press the tape selector button **13** corresponding to the cassette.
3. Set the Accubias switch **26** to the ON position.
4. Set the tape monitor button **15** to the TAPE position.
5. Press the ● REC **20** and ■ PAUSE button **22** together.
6. Slowly rotate the Accubias control knob **27** while holding it down and watch the Accubias level indicator **25**. When the Accubias control knob **27** is depressed, the REC **6** and PLAY **7** indicators will flash on and off, tape transport will automatically begin and the 400 Hz and 12 kHz pilot signals will be generated.
7. Shortly after you depress the Accubias control knob **27**, one of the Accubias level indicators **25** will light.

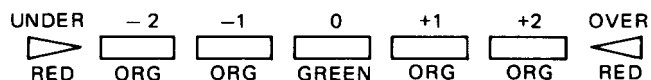

The UNDER, -2 and -1 readings indicate that high end frequency response is too low. In this case, turn the Accubias control knob **27** clockwise until the 0 indicator lights to indicate flat response. The OVER, +1 and +2 readings indicate that high end frequency response is too high. In this case, turn the Accubias control knob **27** counterclockwise until the 0 indicator lights to indicate flat response.

8. When bias adjustment has been completed, release the Accubias control knob **27**. The tape will be automatically rewound to the point where the Accubias adjustment procedure was begun and the deck will go to the REC-PAUSE standby mode. The Accubias level indicator will remain lit to show the setting you have chosen (except OVER and UNDER). However, the bias setting

will be changed if you rotate the Accubias control knob **27** after the deck has returned to the REC/PAUSE mode even though the same Accubias level indicator will still be lit. Consequently, be careful not to turn the Accubias control knob **27** after adjustments have been completed. If you do, the entire Accubias adjustment procedure will have to be repeated.

B. To raise or lower high end frequency response:

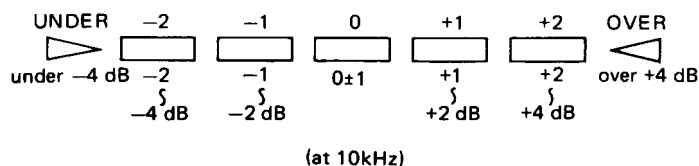

The amount of high end boost or attenuation for each indicator is shown in the above diagram. Adjust the Accubias control knob **27** so that the indicator corresponding to the desired amount of boost or attenuation lights and then make the recording in the normal manner.







Notes:

1. If the Accubias control knob **27** is held down for more than 30 seconds, the tape will not be automatically rewound to the starting point. The memory function can be used to avoid this problem.
2. The Accubias system can not be used if the erasure prevention tabs of the cassette are not intact.
3. Note that because the frequency range covered by some cassette tapes goes beyond that of the Accubias system, it is not possible in some cases to obtain the optimum amount of bias.
4. A mistaken tape selector setting can also prevent you from obtaining the optimum amount of bias.

The Dolby Noise Reduction Systems

There are three types of Dolby noise reduction systems: Dolby A, Dolby B and Dolby C NR. Dolby A NR is used only in professional applications. Dolby B NR is the system that most cassette tape decks use to reduce the background tape noise that is inherent in all cassette tapes. Recently, Dolby Laboratories developed an even more effective noise reduction system, Dolby C NR, in response to the demand for increasingly better sound quality from cassette tapes. All three Dolby noise reduction systems operate by boosting high range signals during recording that fall below a certain input level. That's because tape hiss is most prominent during quiet, high end portions of a recording. These same signals are then reduced back to their original strength during playback thereby reducing the background noise by the same amount. In order to operate only when necessary, the Dolby system has a varying effect depending on the input level and frequency of the material being recorded. Dolby C NR can reduce background noise by as much as 20 dB (above 5 kHz). Since the midrange tends to sound unnaturally strong when noise is suppressed only in the high range, Dolby C NR extends its noise reduction effect down to a lower frequency range than Dolby B NR. In addition to its noise reduction function, Dolby C NR has an antisaturation network that lowers high input levels before recording them and returns the signals to their original strength during playback. This raises the high frequency saturation level of cassette tapes to allow you to record signals that would normally cause distortion. The maximum output level of cassette tapes is increased by more than 4 dB at 10 kHz by this system.

Use the Dolby NR buttons [14] in the following manner:

BUTTON		DOLBY NR
IN/OUT	B/C	
		OUT
		B
		C

Using the Filter Button

When recording an FM broadcast using Dolby NR, the 19 kHz pilot signal and the 38 kHz subcarrier signal included in FM stereo broadcast signals can cause the Dolby circuitry to malfunction. To prevent this from occurring, the TA-2066 is equipped with a filter button so that the Dolby circuitry can be operated through a filter. Therefore, the filter button [12] should be ON (FILTER indicator lit) when recording an FM broadcast using Dolby NR and OFF at all other times.

Using the Timer/Memory Switch

If the ◀◀ REWIND button [9] is pressed when the timer/memory switch [2] is in the MEMORY STOP setting, the tape will be rewound to the point where the tape counter reads [9999] and automatically stopped. In the MEMORY PLAY setting, tape playback will automatically begin from the [9999] point.



Auto Space Recording Pause

The || PAUSE button [22] is normally used to cut out unwanted portions of a program (commercials, conversations, etc.) during recording operations. However, this often results in a tape where the next song begins immediately after the last one. The Auto Space button [23] is provided to solve this problem. To use this button, just press it once at the point in the recording where you want to enter a blank section about five seconds long. When the Auto Space button [23] is pressed, the play indicator flashes on and off and tape transport continues. However, no signal is recorded on the tape for a period of about five seconds. After a blank portion has been inserted, tape transport automatically stops and the deck returns to the REC/PAUSE standby mode. To insert a blank section of tape less than five seconds long, press the ▶ PLAY button [11] before the five second period has elapsed to return to the recording mode or press the || PAUSE button [22] to return to the REC/PAUSE standby mode. To insert a blank section of tape more than five seconds long, keep the Auto Space button [23] depressed for as long as you want the blank section to be. The deck will return to the REC/PAUSE standby mode immediately after the button is released. To continue recording, press the ▶ PLAY button [11] to release the pause mode. This button is very useful for making blank sections of sufficient length for automatic program sensing systems (such as AMCS) that operate by detecting the blank sections between songs.

Using the AMCS Function

The AMCS (Automatic Music Control System) automatically locates the beginning of each song on a tape and plays the first 15 seconds (approximately) of each one. It is particularly useful to rapidly check the contents of a cassette. When AMCS >> [24] is pressed during normal tape playback, the tape is rapidly wound to the beginning of the next song and, as the play indicator flashes on and off, the first 15 or 16 seconds of that song is played. Then the tape is rapidly wound to the beginning of the next song and, again, the first 15 or 16 seconds is played. This process is repeated until the ▶ PLAY button [11] is pressed or the end of the tape is reached. When AMCS << [24] is pressed, the same process is performed in the reverse direction. If you want to hear the entire song, press the ▶ PLAY button [11] to cancel the AMCS function and return to normal playback.

The AMCS circuit operates by detecting the blank sections between songs. If the space between songs is too short, the AMCS circuit may go on to the next blank space of sufficient length. In order to assure that the blank sections between songs on your cassettes are long enough, you should use the auto space button to insert these spaces when making recordings.

Note:

AMCS << may not operate properly if there is a very quiet section followed by a very loud section in the 15 to 16 second portion played back at the beginning of one of the songs. If this happens, press AMCS << again to continue AMCS reverse operation.

THE ACCUBIAS CIRCUIT

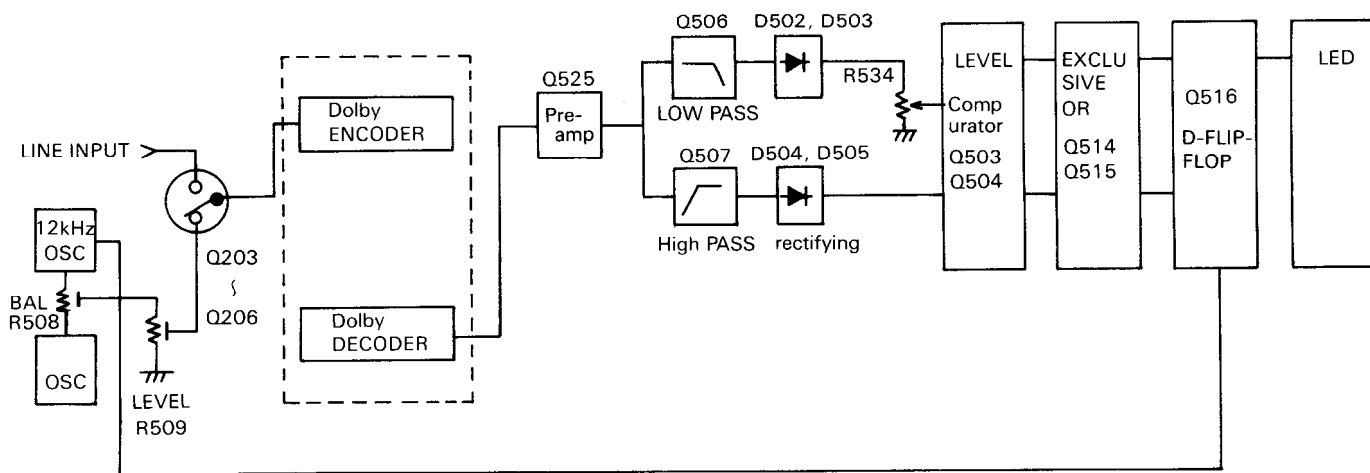

ACCUBIAS CIRCUIT BLOCK DIAGRAM

1. SIGNAL FLOW

When the ACCUBIAS switch is turned on and the ACCUBIAS calibration knob is pressed in, a 12KHz and 400Hz signal are generated. At the same time, the signal is switched from the line side to the ACCUBIAS side by electronic switches Q203-Q206. The signal consisting of the mixed 12KHz and 400Hz frequencies passes through the recording circuitry and is recorded on the tape. This signal is then retrieved by the playback head (using the right channel), amplified by Q525, passed through the filters (Q506, Q506) and divided back into the original two frequencies.

The signals are then converted into DC voltages by the rectifying circuits (D502-D505) and the 12KHz and 400Hz components are each fed to the level comparator where the DC voltage of the 400Hz component and the DC voltage of the 12KHz component are compared. In order to light the ACCUBIAS LEDs one by one, the signal passes through an EXCLUSIVE OR type circuit and to permit hold for the five center LEDs, the signal passes through a D FLIP-FLOP circuit (Q516). Hold is done by shaping the 12KHz signal and applying it to CK (clock input) of Q516. As long as a clock input is being received, the D FLIP-FLOP continues to supply an input signal. When the clock input stops, one of the five inputs is held regardless of which one it is. When the ACCUBIAS ON/OFF switch is turned off, the Q516 CL (clear) input goes to low to release hold. When power is turned on, the CL input is reset so that no LED is lit.

Q508-Q513 (see circuit diagram) are used in order to drive the LINE input and ACCUBIAS input switching and the power on/off switching for the level comparator.

Notes :

To perform ACCUBIAS adjustment :

1. The erasure-prevention tabs must be intact.
2. The tape monitor switch must be in the TAPE setting.
3. The ACCUBIAS ON/OFF switch must be on.
4. The deck must be in the REC/PAUSE mode

If these four conditions are met, ACCUBIAS operation can begin.

2. THE COUNTER CIRCUIT

The rotation detection pulse is input to an up count input (pin 18) for FF and PLAY and a down count input (pin 17) for REW. The signal from the reel motor drive terminal of the microprocessor (Q701) is used to distinguish between up and down count. The counter is set up so that one rotation detection pulse is one count. Since the IC (Q780) lights each digit dynamically, it has an internal oscillation circuit and the oscillation frequency is controlled by a single resistor (R786). The digits are driven from pins 8-11 while pins 1-7 drive the segments. The signal for memory stop and play is received from the borrow terminal (pin 23) when the counter goes from 0000 to 9999 and passed through an inverter to control pin 28 of the microprocessor.

BLOCK DIAGRAM

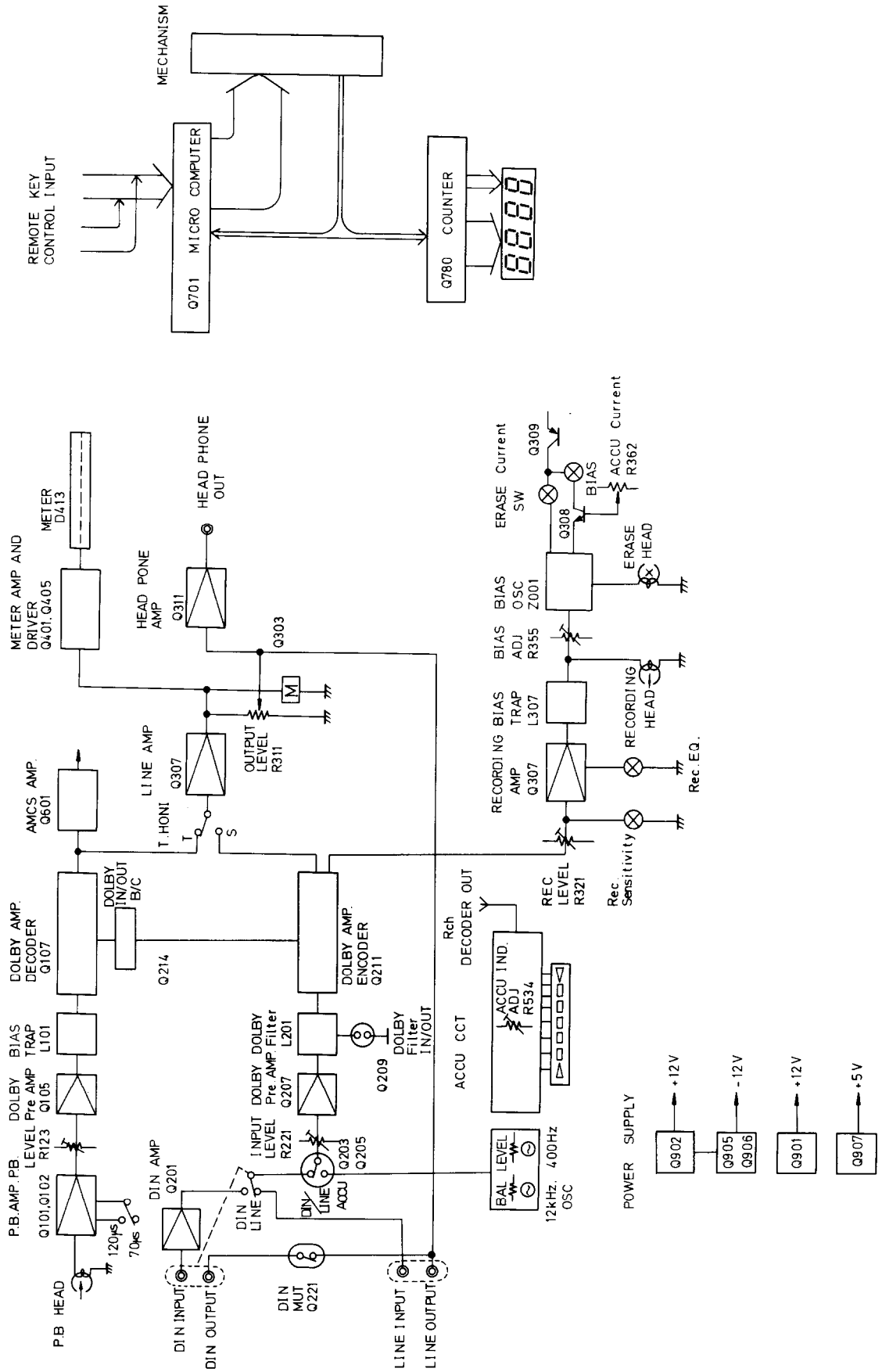

TMP4315AP-1011

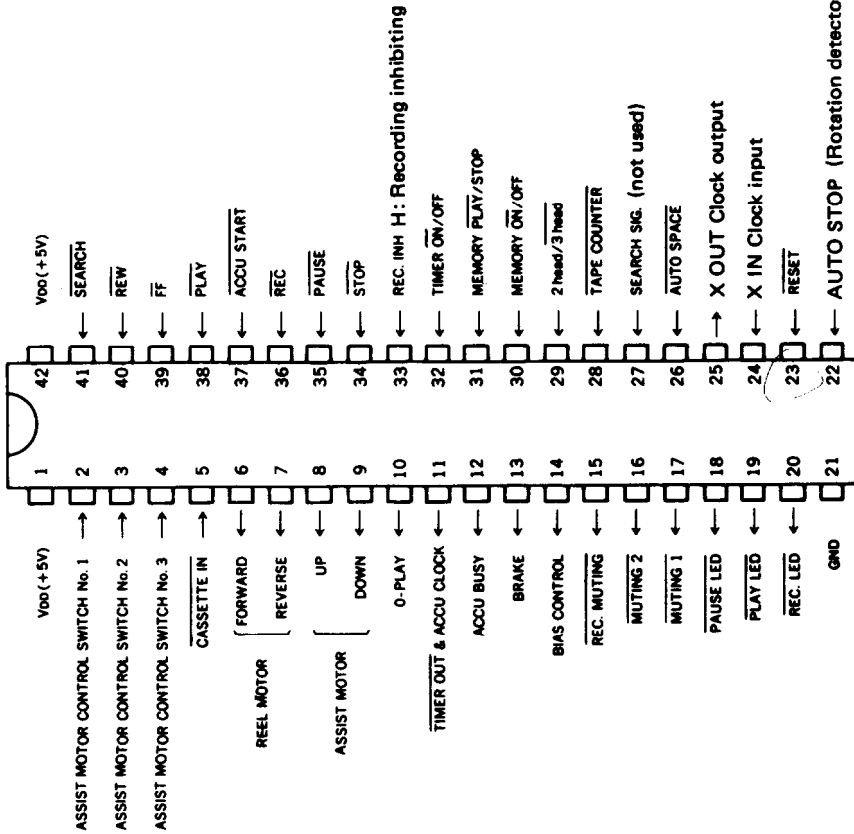

HA12038 (DOLBY B & C TYPE NOISE REDUCTION SYSTEM)

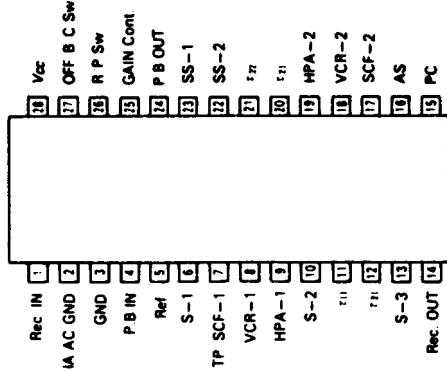

TC-5054P

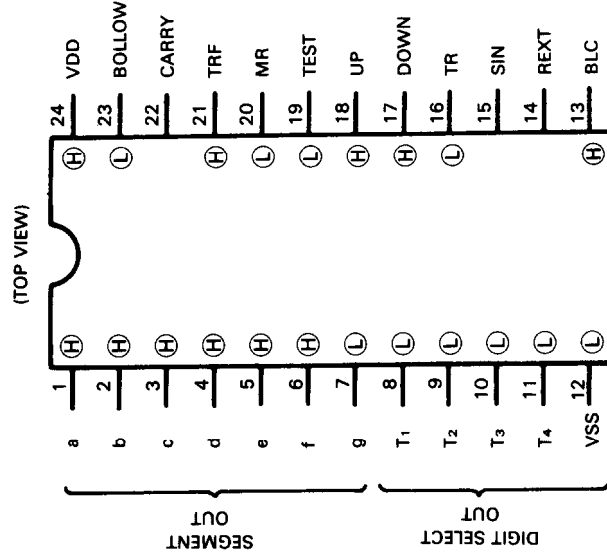

PACKING VIEW

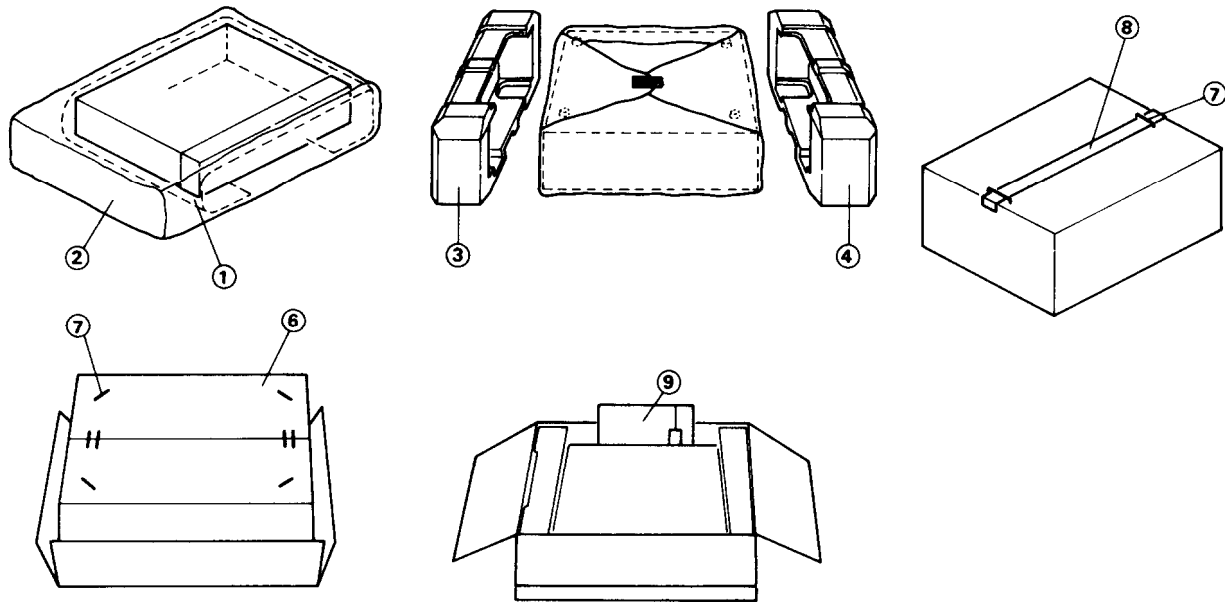

D model

REF. No.	PARTT NO.	DESCRIPTION
1	29095012-1	500×800mm, Protection sheet
2	29100034	650×850mm, Poly bag
3	29090769	Pad, right
4	29090770	Pad, left
6	29050656	Master carton box
7	282301	Sealing hook
8	260012	W-500mm, Damplon tape
9		Accessory bag ass'y
	29340680	Instruction manual
	253074	Connection cable
	29365006-1	Warranty card
	29358002	Service station list
	29100005	220×330mm, Poly bag

G/W model

REF. No.	PARTS NO.	DESCRIPTION
1	29095012-1	500×800mm, Protection sheet
2	29100034	650×850mm, Poly bag
3	29090769	Pad, right
4	29090770	Pad, left
6	29050656	Master carton box
7	282301	Sealing hook
8	260012	W-500mm, Damplon tape
9		Accessory bag ass'y
	29340681	Instruction manual
	253074	Connection cable
	29365005-3	Warranty card [G]
	25055040	CV-K-2, Conversion plug [W]
	29100005	220×330mm, Poly bag

[G] : Only West Germany model
 [W] : Only 120/220 V model

ADJUSTMENT PROCEDURES

NAAF - 1668

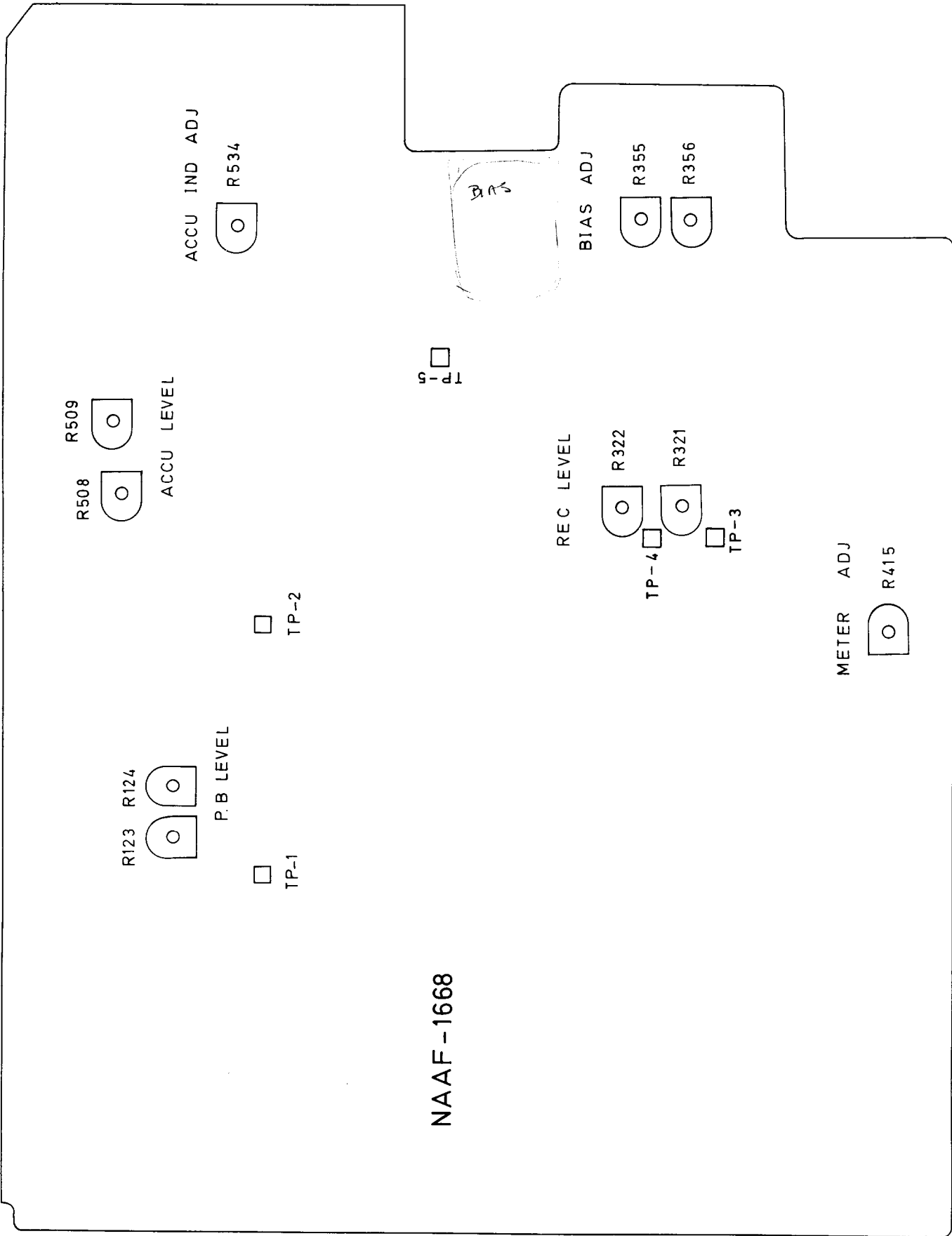

ADJUSTMENT PROCEDURES

PRECAUTIONS

- Before adjustment, clean the following parts with an alcohol moistened swab.
 - * record/playback head
 - * pinch roller
 - * erase head
 - * capstan
- Do not use magnetized screwdriver for adjustments.
- Demagnetize record/playback head with a head demagnetizer.

TEST EQUIPMENT/TOOLS REQUIRED:

Audio oscillator
 Digital frequency counter
 Oscilloscope
 Attenuator
 AC voltmeter DC voltmeter
 Non-magnetic screw driver

Blank tapes(completely erased)

NORMAL.....NEW UD90
 HIGH.....NEW XL-II 90
 METAL.....NEW MX60

Test tapes

VTT-658 : 10 kHz, -15dB
 MTT-111 : 3 kHz, -10dB
 MTT-150 : Dolby level calibration
 400Hz tone 200nWb/m
 MTT-215C : 315Hz, 10kHz
 TW-2111 : Torque meter
 MC-112C : Mirror tape

Item	Connection of instrument	Line input	Test tape	Mode	Output indicator	Adjustment point	Adjust	Remarks	
1	Playback torque		TW-2111	PB	TW-2111	R705	35 to 55gcm		
2	Tape speed	Frequency counter to LINE output terminal	MTT-111	PB	Frequency counter	Semi-fixed on the moter	3,000 to 3,010Hz		
3	Head azimuth	AC voltmeter and oscilloscope to LINE output terminal	VTT-658	PB	AC voltmeter	Head azimuth screws	Maximum and same phase at channels L and R.	See fig. 1 Set the semi-fixed resistors R123 and R124 to center position.	
4	Playback level	AC voltmeter terminals TP-1 and TP-2.	MTT-150	PB	AC voltmeter	R123(Ch.L) R124(Ch.R)	580mV		
5	Meter		MTT-150	PB	Level meter	R415	0dB indicator lights on		
6	Bias current	Fig. 2	1kHz, -20dB and 12kHz, -20dB	NEW XL-II 90	REC/ PB	AC voltmeter	R335(Ch.L) 336 (Ch.R)	Same level at REC/PB	INPUT VOLUME.....maximum
7	Record level	Fig. 2	1kHz		REC PAUSE	AC voltmeter AC voltmeter	Attenuator or AF OSC output R321 R322	580mV Same level at source and tape position of MONITOR switch	INPUT VOLUME...maximum ACCUBIAS ON/OFF.....OFF
8	<p>ACCUBIAS oscillator level and indicator adjustment</p> <ol style="list-style-type: none"> Connect the oscilloscope and AC voltmeter to the terminal TP-3 or TP-4 and the DC voltmeter to the terminal TP-5. Insert the blank tape NEW XL-II (high position) into the cassette holder. Set the ACCUBIAS ON/OFF switch to ON position and the MONITOR switch to TAPE. Push the REC. and PAUSE buttons together. While pushing the ACCUBIAS CAL volume, adjust the semi-fixed resistor R508 so that the 400Hz and 12kHz mixing signal becomes same level as shown right and R509 so that the AC voltmeter becomes 60mV. Release the PAUSE button and adjust ACCUBIAS CAL volume for the same indication of DC voltmeter when the ACCUBIAS ON/OFF switch is switched on and off. (note: Don't push the ACCUBIAS CAL volume.) Push the PAUSE button and push the ACCUBIAS CAL volume. Confirm that the indicator of DC voltmeter is same level when the ACCUBIAS CAL volume is pushed and not pushed. Adjust the R534 so that the green L.E.D of ACCU indicator lights. 								

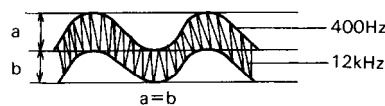

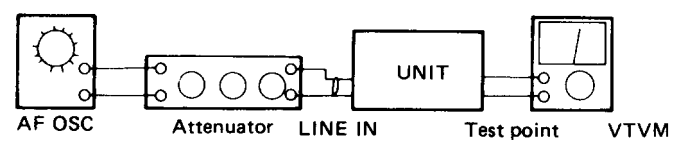
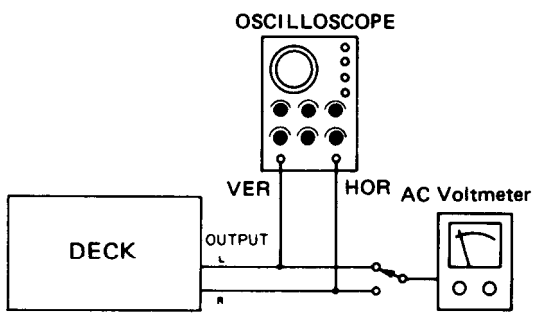
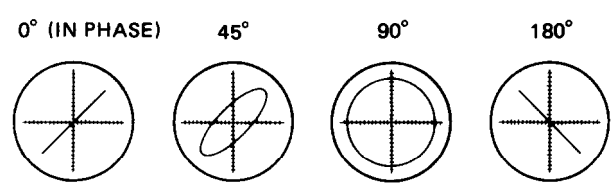

fig-2



Confirming phase relationship

fig-1

HEAD LEAD CONNECTION

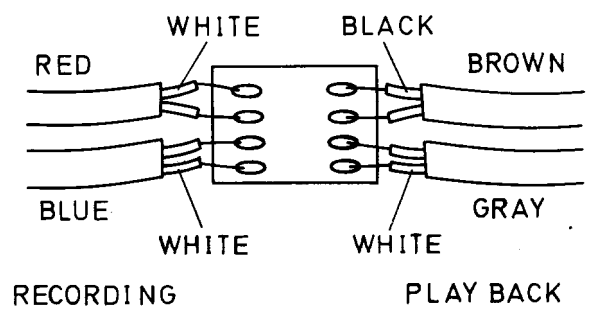
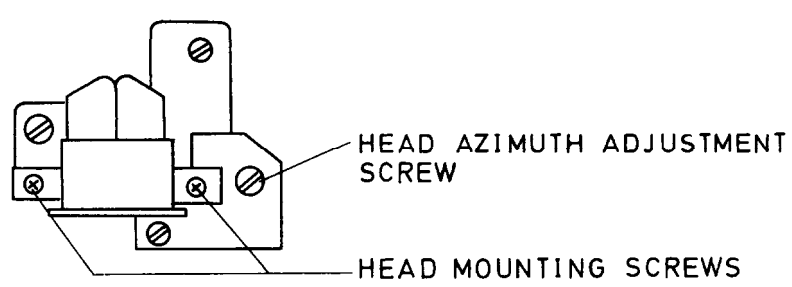

TAPE MECHANISM-PARTS LIST

REF. NO.	PARTS NO.	DESCRIPTION
3	24610955	Chassis
15	833125059	2.5 x 5, Pan head screw
23		Connector, erase head
24		Connector, Rec. head
25		Connector, Pb. head
28		E3, Circlip
29		E2, Circlip
33	9930302	Cassette holding spring
33	24605450	1.8 x 3.2 x 0.5, Washer
36	24610349	2.5 x 4.7 x 0.25, Washer
37	24610515	2.5 x 5.5 x 0.13, Washer
38	24610952	1.8 x 8 x 0.15, Washer
39	24610953	Washer
40	870081	Reel stand ass'y
44	24602226	Pulley
47	24602131	Magnet pulley ass'y
49	24602227	Belt
52	24602132	Tension spring
55	24605461	Tension spring
57	24605460	Connector switch ass'y
64	24606174	Leafswitch
65	24606175	Connector pc board ass'y
66	24606175	DN6838, Hall IC
67	222558	Rec. lever
71	24603205	Pc board
77	24606135	1S1885, Diode
78	223802	2 x 4, Pan head screw
82	801250	Protection plate
84	24610659A	DD motor
90	24601114	3mm, Steelball
90	24610270	3mm, Steelball
95	24610270	Head holding plate
96	24610749	Nut for volume
99	24610705	Lamp holder ass'y
102	24606168	Blinder
104	26020530	Pinch roller arm ass'y
107	24605370	Tension spring
112	24605370	Locked plate
114	24610345	Collar
118	24610344	Tension spring
120	24605184	Cassette spring
122	833125109	2.5 x 10, Pan head screw
126	24610939	Side bracket R
131	24610941	Side bracket L
133	24610940	Cassette holder
135	24610508	Damper unit
138	24605406	Tension spring
140	891024	CS ring
142	24605186	Cassette spring
148	801252	2 x 1.2, Thru screw
150	24600025	Erase head
157	24606173	Lamp holder
158	24610498	Head base ass'y
159	24610951	Head base
170	24610956	Head block
170a	24610651	Rec/pb head
170b	24600037	Collar
170c	24604053	Collar
170e	24604054	Tension spring
170f	24605462	2 x 4, Screw
170g	801251	Adjusting nut
170h	24610495	Shaft
170i	24610652	Unit ass'y
171	24601140	Plate
171a	24601103	Motor 14.00
171b	24606119	Leafswitch
171c	24602133	Cam gear
171d	833125209	2.5 x 20, Pan head screw
171e	801259	2 x 3, Pan head screw
171f	24601141	Motor plate ass'y
172	24610654	Plate
172a	24610371	Case, reel stand
172b	24610494	Brake
172c	24610494	Reel motor ass'y
172e	24601106A	Idler
172j	24602225	Washer
172k	24610622	Pulley, motor
172m		

TAPE MECHANISM-EXPLODED VIEW

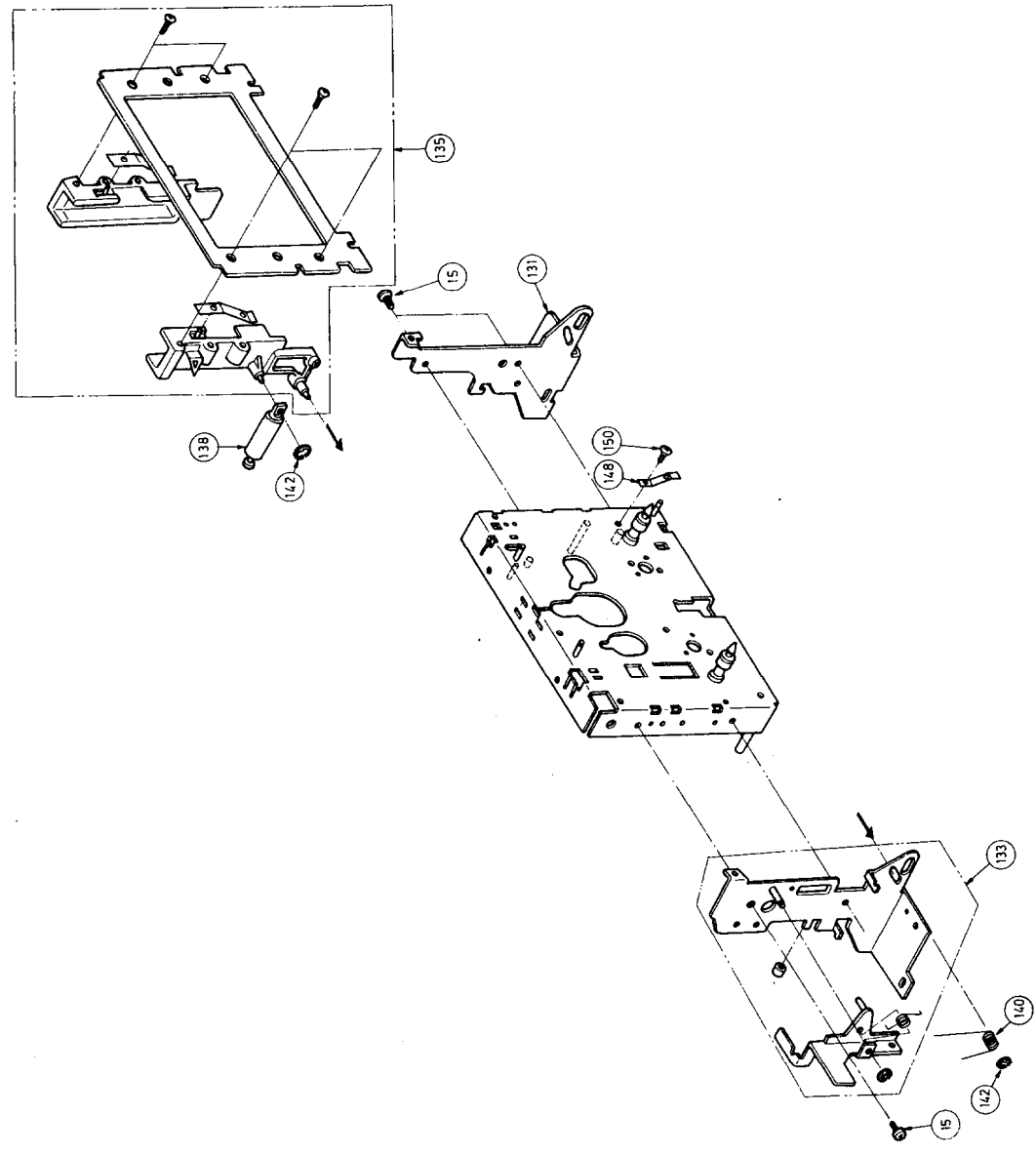

PLAIN THAT RECORDING BECAME WORSE UNTIL I RAN ON THE
 IN HOT AIR SHOWS INCREASE IN NOISE & FLUTTER FROM 0.04 TO 0.15
 IN FAST AND SLOW THERE (ABOUT 0.15% W & F) REPAIRS
 BY MOTOR ASSY AND LOOKS THE PROBLEM WAS SOLVED.

MECHANISM-EXPLODED VIEW

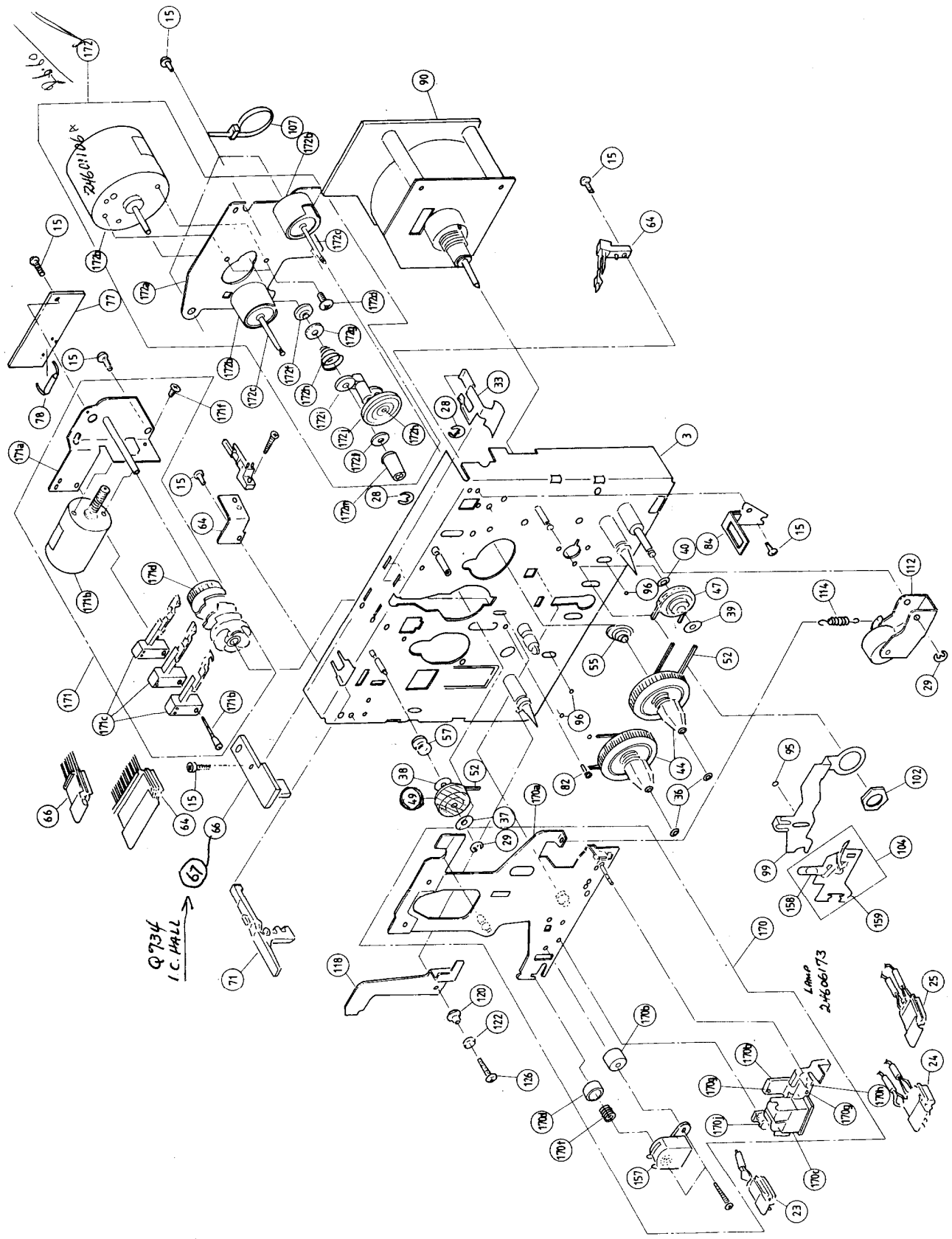

CHASSIS EXPLODED VIEW -PARTS LIST

REF. NO.	PARTS NO.	DESCRIPTION	REF. NO.	PARTS NO.	DESCRIPTION
1	16048121	Front panel ass'y	U1	16048568	NAAF-1668, Rec. and playback amplifier pc board ass'y (D)
	16028121	Front panel ass'y (S)		16054568A	NAAF-1668a, Rec. and playback amplifier pc board ass'y (G/W)
2	28400133A	Window	U2	16048569	NAAF-1669, Switch circuit pc board ass'y (D)
	28400138	Window (S)		16054569A	NAAF-1669a, Switch circuit pc board ass'y (G/W)
3	16048901	Cassette lid ass'y	U3	16048570	NAPS-1670, Power supply circuit pc board ass'y
4	28191171	Clear plate, edge	U4	16048571	NACOC-1671, Control circuit pc board ass'y
5	27190194	Holder, LED	U5	16048572	NASW-1672, Operation switch pc board ass'y
6	27262217A	Plate, LED	U6	16048573	NASW-1673, Timer switch pc board ass'y
7	28321019A	Knob,	U7	16048574	NALED-1674, Counter indicator LED pc board ass'y
	28320834A	Knob,	U8	16048575	NALED-1675, Tape selector indicator pc board ass'y
8	27180142	Spring	U9	16048576	NARM-1676, Remote control switch terminal pc board ass'y
9	28321034	Knob, left	U10	16048577	NAPL-1677, Illumination lamp pc board ass'y
	28321033	Knob, left (S)	U11	16048578	NADR-1678, Accu. LED driver pc board ass'y
10	28321032	Knob, right	U12	16048579	NALED-1679, Accu. LED pc board ass'y
	28321031	Knob, right (S)	P401a	260208	Binder
11	2814015	40mm, Cushion		2000233	NSAS-12P-168, Socket
12	28321149	Knob, selector			
	28321149	Knob, selector (S)			
13	28321105	Knob, level			
	28320849A	Knob, level			
14	28321104	Knob M			
	28321154	Knob M (S)			
15	28321074A	Knob, band			
	28321073A	Knob, band (S)			
16	28321028	Knob, eject			
	28321027	Knob, eject			
17	27180179	Spring			
18	28321024	Knob, power			
	28321023	Knob, power (S)			
19	28320828C	Base, Knob			
20	27300532	Holder			
21	27190206A	Holder S			
22	28199086A	Film			
23	25045132	Stereo headphone jack			
24	225129	L.E.D for level meter			
25	244047	NDM-42, Tape mechanism			
26	16048704	Plate, cassette holder			
27	28140408	Cushion			
28	28184181	Top cover			
	28184180	Top cover (S)			
29	27170150	Bottom board			
30	27175011C	Leg			
31	27115139	Side bracket			
32	27110195A	Front bracket			
33	27120486A	Back panel (D)			
	27120487A	Back panel (G)			
	27120488A	Back panel (W)			
34	27130331C	Bracket, power transformer			
35	27190009	Holder			
36	27273023A	Joint C			
37	28175074	Insulating plate			
38 Δ	25035224	NPS-121-L188P, Power switch (D)			
Δ	25035192	NPS-122-L156P, Power switch (G/W)			
39 Δ	3500065A	103P400VAC, Capacitor IS			
	27300080	Cover, capacitor			
40 Δ	230701	NPT-810D, Power transformer (D)			
Δ	230702	NPT-810G, Power transformer (G)			
Δ	230703	NPT-810DG, Power transformer (W)			
41	870065	Special washer			
42	86414010	FWN4x10FN, Flange nut			
43	210153	60mA, 14V, Lamp			
44	210146	60mA, 14V, Lamp			
45	210147	60mA, 14V, Lamp			
46	210149	60mA, 14V, Lamp			
47	253099B-1	AS-UC-3, Power supply cable (D)			
	253083-1	AS-CEE, Power supply cable (G/W)			
48	270025	SR-3P-4, Strainrelief (D)			
	270280	SR-4K-4, Strainrelief (G/W)			
49	25065123	CV-K-2, Voltage selector switch (W)			
50	25050070	DIN socket			
51	834430068	3TTS+6B (BC), Tapping screw			
52	838440089	4TTB+8C (BC), Tapping screw			
53	27300397-1A	Special screw			
54	870100	Washer			
55	834426068	2.6TTS+6B (BC), Tapping screw			
56	831430088	3TTW+8B (BC), Tapping screw			
57	82142604	2.6P+4F (BC), Pan head screw			
58	82142604	2.6P+4F (BC), Pan head screw			
59	801230	3STS+8BQ (BC), Tapping screw			
60	838130088	3TTB+8B, Tapping screw			

NOTE : THE COMPONENTS IDENTIFIED BY MARK Δ ARE CRITICAL FOR RISK OF FIRE AND ELECTRIC SHOCK. REPLACE ONLY WITH PARTS NUMBER SPECIFIED.

A B C D E F G

SCHEMATIC DIAGRAM

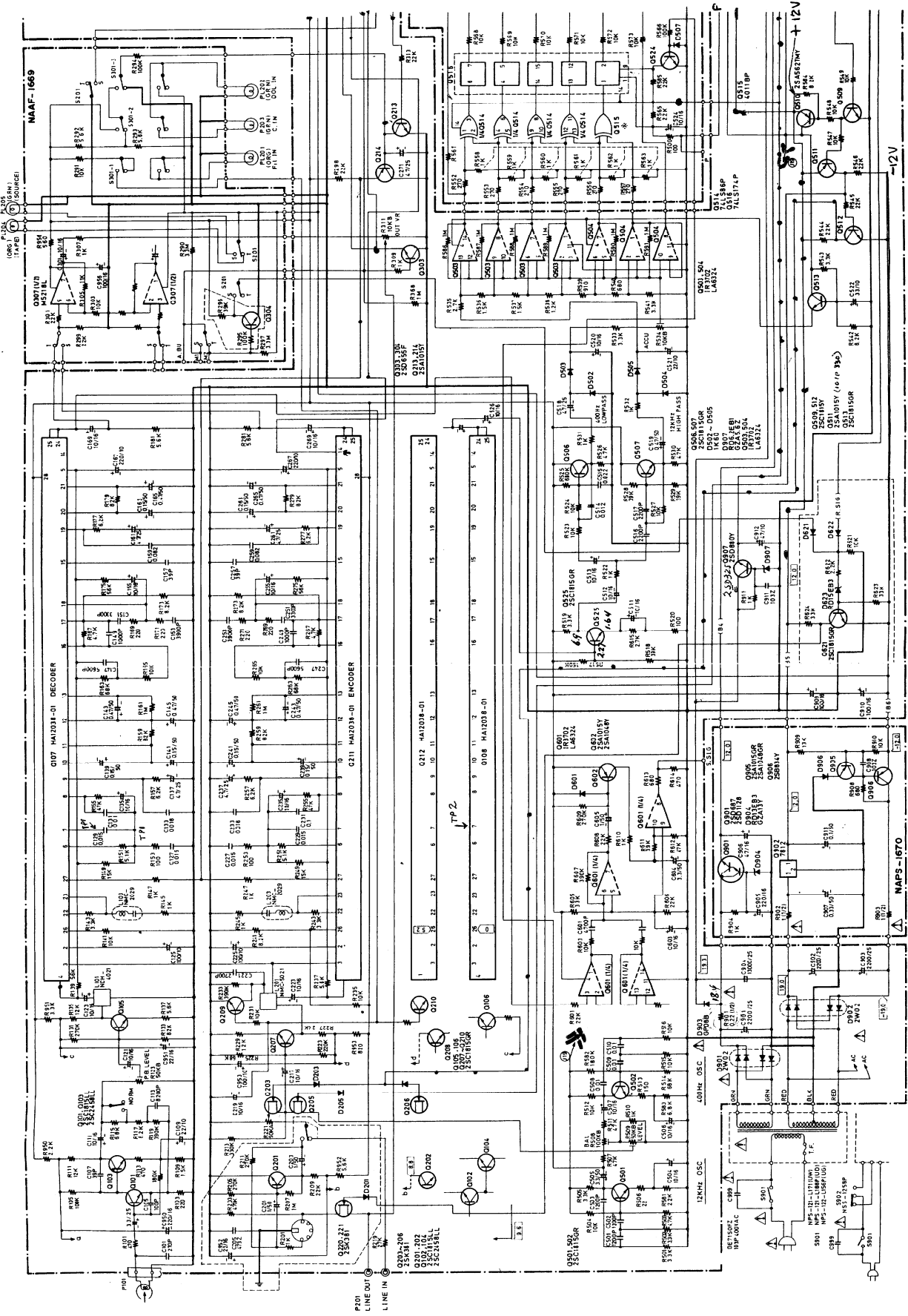

PARTS LIST

CONTROL CIRCUIT PC BOARD(NACOC-1671)

CIRCUIT NO.	PARTS NO. ICs	DESCRIPTION
Q701	222637	TMP4315AP-1011
Q780	222700	TC5054P
	Transistore	
Q702	2211563	2SB562 (C)
Q703	2201060	2SD549
Q704, Q705	2211554	2SA562TM (Y)
Q706, Q707	2211952	2SC1472K (B)
Q708	2211254, 2212114 or 2210747	2SC1815 (Y) , 2SC2458 (Y) or 2SC945A (Q1)
Q709	2201074	2SD880 (Y)
Q710, Q711	2211563	2SB562 (C)
Q712, Q713	2211253 or 2212113	2SC1815 (O) or 2SC2458 (O)
Q714, Q715	2211683	2SD468 (C)
Q716	2211706	2SD655 (F)
Q717, Q718	2211254, 2212114 or 2210747	2SC1815 (Y) , 2SC2458 (Y) or 2SC945A (Q1)
Q731-Q733	2211454, 2212124 or 2210804	2SA1015 (Y) , 2SA1048 (Y) or 2SA733A (Q)
Q719-Q725	2211454, 2212124 or 2210804	2SA1015 (Y) , 2SA1048 (Y) or 2SA733A (Q)
Q729	2211256, 2212116 or 2210748	2SC1815 (BL) , 2SC2458 (BL) or 2SC945A (K)
Q730	2211454, 2212124 or 2210804	2SA1015 (Y) , 2SA1048 (Y) or 2SA733A (Q)
Q781, Q782	2211254, 2212114 or 2210747	2SC1815 (Y) , 2SC2458 (Y) or 2SC945A (Q1)
Q783-Q786	2211256, 2212116 or 2210748	2SC1815 (BL) , 2SC2458 (BL) or 2SC945A (K)
Q787, Q788	2211254, 2211253, 2212114 or 2212113	2SC1815 (Y) , 2SC1815 (O) , 2SC2458 (Y) or 2SC2458 (O)
Q789	2211255, 2212115 or 2210746	2SC1815 (GR) , 2SC2458 (GR) or 2SC945A (P)
	Diodes	
D701	2239552 or 2241031	RD8.2EB2 or GZA8.2X
D702	223145, 223105 or 223133	1S2076TD, 1S1555 or DS442X
D703-D711	223132	1K60
D712, D713	223105 or 223133	1S1555 or DS442X
D714	2240953 or 2239491	GZA5.6Z or RD6.2EB1
D718-D783	223145, 223133 or 223105	1S2076TD, DS442X or 1S1555
	Transformer	
L701	232100	NMIF-6030
	Capacitors	
C703	352741009	10 μ F, 16V, Elect.
C705-C707	352780109	1 μ F, 50V, Elect.
C710	352781099	0.1 μ F, 5V, Elect.
C711	352741009	10 μ F, 16V, Elect.
C714	352721019	100 μ F, 6.3V, Elect.
C715	352750479	4.7 μ F, 25V, Elect.
C717	352780109	1 μ F, 50V, Elect.
C781	352741009	10 μ F, 16V, Elect.
C782	352750479	4.7 μ F, 25V, Elect.
	Resistors	
R702	441722704	27ohm, 2W, Metal oxide film
R705	5215044	N08HR5KBC, Semi-fixed
R715-R724	49121392410	3.9kohm \times 10, 1/8w, Network
R725	441521004	10ohm, 1/2w, Metal oxide film
R743-R746	49121222404	2.2 kohm \times 4, 1/8w, Network
R752-R761	49121222410	2.2kohm \times 10, 1/8w, Network
	Plugs	
P701	25055047	NPLG-12P35
P702	25055042	NPLG-3P32
P703	25055047	NPLG-12P35
	Lamp	
PL101	210149	PL14VO.06AW30

SWITCH PC BOARDS(NANASW-1672/1673)

CIRCUIT NO.	PARTS NO. ICs	DESCRIPTION
	(NASW-1672)	
S701-S711	25035275	NPS-111-S239, Push switches
P701a	2000229	NSAS-12P133, Socket
	(NASW-1673)	
	25030233	NRS-145-20SBU, Rotary switch, timer
	(NALED-1674)	
D783	225148	TLG-4145, L.E.D
	(NALED-1675)	
D712	225141	SEL2213C, L.E.D
D713	225137	SEL2413E, L.E.D
D714-D717	225142	SEL2913K, L.E.Ds
	2750060	Case lamp
	(NALED-1679)	
D508	225124	SLP-173B-01, L.E.D
D509, D510	225147	SLP-473B-01, L.E.Ds
D511	225125	SLP-237B-01, L.E.D
D512, D513	225147	SLP-473B-01, L.E.Ds
D514	225124	SLP-173B-01, L.E.D
	27190206A	Holder S
P701	25050070	NSCT-7P20, DIN terminal
PL902	210165	14V, 150mA, Lamp
	ICs	
Q514	222740861	74LS86P
Q515	222840111	4011BP
Q516	222741741	74LS174P
	Transistors	
Q517-Q524	2211255, 2212115, 2210746 or 2211256	2SC1815 (GR) , 2SC2458 (GR) , 2SC945A (P) or 2SC1815 (BL)
	Diode	
D507	223105, 223133 or 223145	1S1555, DS442X or 1S2076TD
	Capacitor	
C524	352741009	10 F, 16V, Elect.
	Resistor	
R558-R563	49121102406	1kohm \times 6, 1/8W, Network

SCHEMATIC DIAGRAM

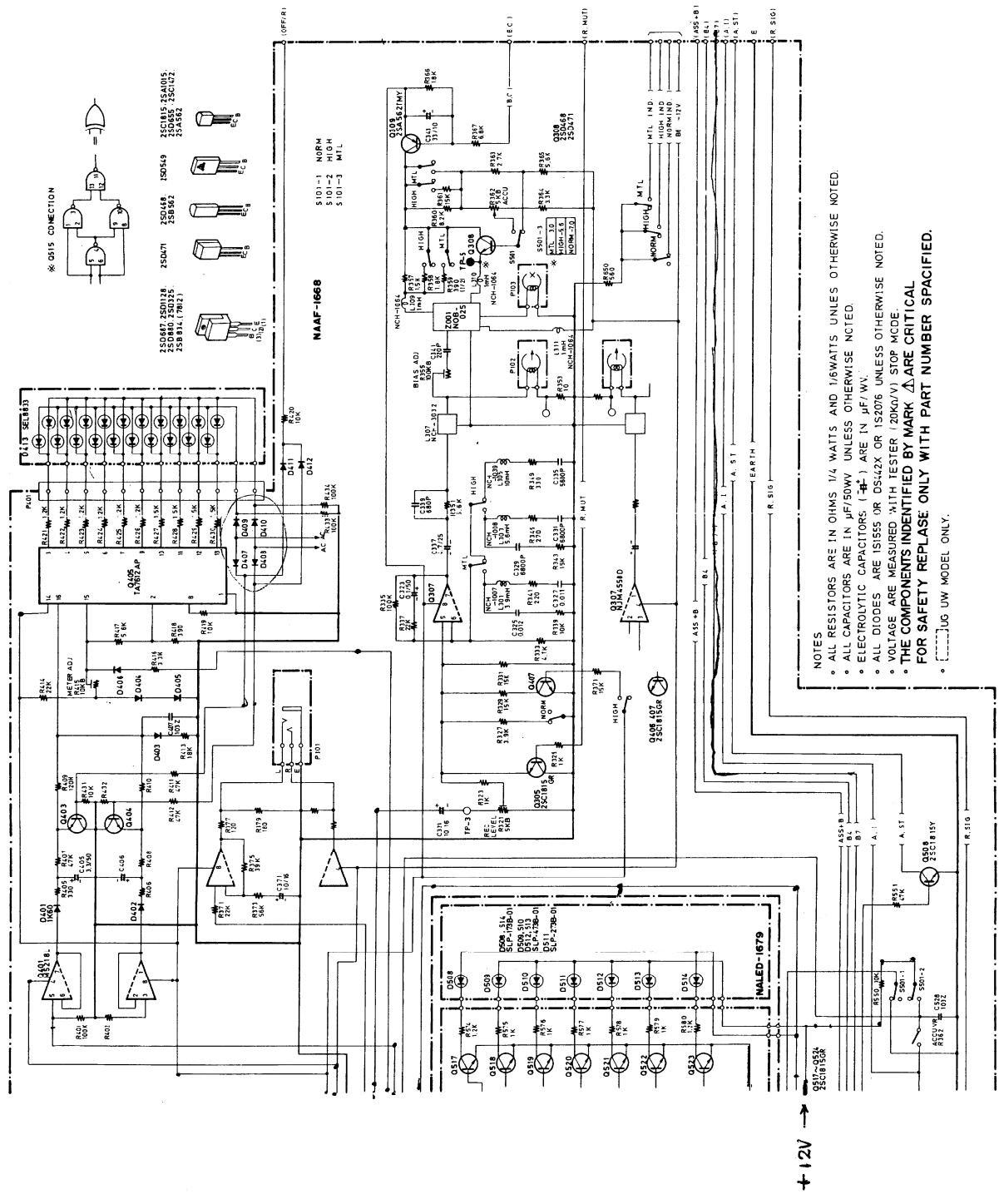

- NOTES
- ALL RESISTORS ARE IN OHMS 1/4 WATTS AND 1/8WATTS UNLESS OTHERWISE NOTED.
 - ALL CAPACITORS ARE IN μ F/50WV UNLESS OTHERWISE NOTED.
 - ELECTROLYTIC CAPACITORS (E) ARE IN μ F/WV.
 - ALL DIODES ARE 1S1555 OR DS42X OR 1S2076 UNLESS OTHERWISE NOTED.
 - VOLTAGE ARE MEASURED WITH TESTER (20K Ω /V) STOP MCDE.
 - THE COMPONENTS IDENTIFIED BY MARK Δ ARE CRITICAL FOR SAFETY REPLACE ONLY WITH PART NUMBER SPECIFIED.
 - \square JUG UW MODEL ONLY.

SCHEMATIC DIAGRAM

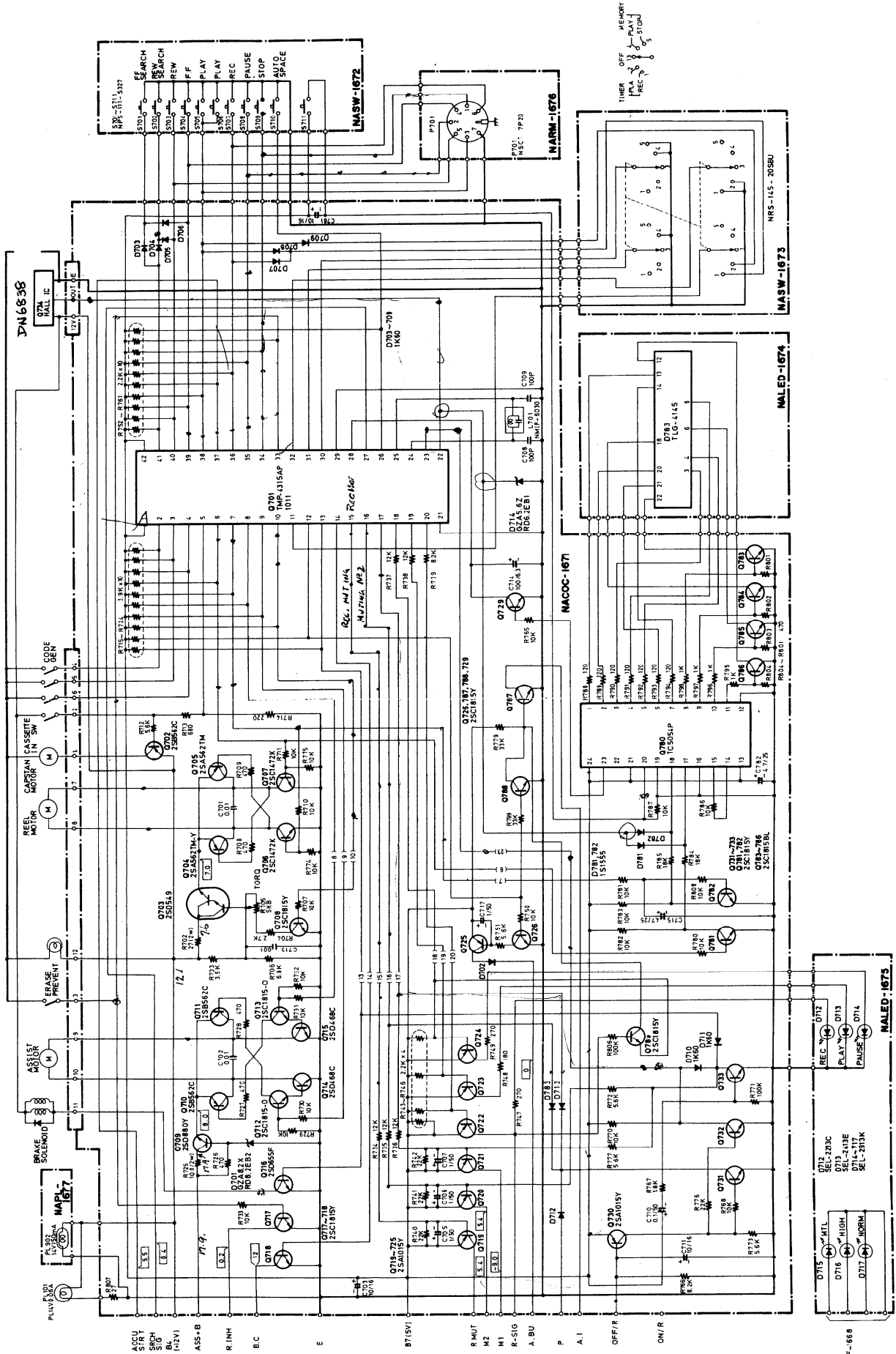

PRINTED CIRCUIT BOARD-PARTS LIST

REC. AND PLAYBACK AMPLIFIER PC BOARD(NAAF-1668)

CIRCUIT NO.	PARTS NO.	DESCRIPTION			
	ICs				
Q107, Q108	222721 or	HA-12038-01G or			
Q211, Q212	222722	HA-12038-01Y			
Q307	222465	NJM4558D			
Q311, Q401	222652	M5218L			
Q405	222507	TA7612AP			
Q503, Q504	222681 or	IR3702 or			
Q601	222695	LA6324			
	Transistors				
Q101-Q104	2212256 or	2SC2458 (LL) or	C169, C170	352741009	10 μ F. 16V. Elect.
Q201, Q202	2211896	2SC1815 (LL)	C201, C202	392880107	1 μ F. 50V. LL
Q105, Q106	2211255.	2SC1815 (GR)	C203, C204	352780109	1 μ F. 50V. Elect.
Q207-Q210	2212115.	2SC2458 (GR)	C217-C219	352741009	10 μ F. 16V. Elect.
Q305, Q306	2210746 or	2SC945A (P) or	C223, C224	352741009	10 μ F. 16V. Elect.
Q403, Q404	2211256	2SC1815 (BL)	C225, C226	352731019	100 μ F. 1V. Elect.
Q203-Q206	2212302	2SK381 (B)	C235, C236	392841007	10 μ F. 16V. LL
Q220, Q221	2212303 or	2SK381 (C) or	C237, C238	352750479	4. 7 μ F. 25V. Elect.
	2212304	2SK381 (D)	C239-C242	352781599	0. 15 μ F. 50V. Elect.
Q214	2211455 or	2SA1015 (GR) or	C243-C246	352784799	0. 47 μ F. 50V. Elect.
	2212125	2SA1048 (GR)	C255, C256	392841007	10 μ F. 16V. LL
Q303, Q304	2211706	2SD655 (F)	C261, C262	352750479	4. 7 μ F. 25V. Elect.
Q308	2211683 or	2S468 (C) or	C263, C264	352781599	0. 15 μ F. 50V. Elect.
	2211612	2SD471 (L)	C265, C266	352784799	0. 47 μ F. 50V. Elect.
Q309	2211554	2SA562TM (Y)	C267, C268	352732219	220 μ F. 10V. Elect.
Q406, Q407	2211254 or	2SC1815 (Y) or	C269, C270	352741009	10 μ F. 16V. Elect.
	2211255.	2SC1815 (GR)	C271	352750479	4. 7 μ F. 25V. Elect.
Q501, Q502	2211255.	2SC1815 (GR)	C321, C322	352741009	10 μ F. 16V. Elect.
Q506, Q507	2212115.	2SC2458 (GR)	C323, C324	352781099	0. 1 μ F. 50V. Elect.
Q525, Q621	2210746 or	2SC945A (P) or	C337, C338	352780479	4. 7 μ F. 50V. Elect.
	2211256	2SC1815 (BL)	C343	352733309	33 μ F. 10V. Elect.
Q508, Q509	2211254.	2SC1815 (Y)	C371, C372	352741009	10 μ F. 16V. Elect.
Q512	2211253.	2SC1815 (O)	C405, C406	352780339	3. 3 μ F. 50V. Elect.
	2212114 or	2SC2458 (Y) or	C504	352741009	10 μ F. 16V. Elect.
	2212113	2SC2458 (O)	C505	352780339	3. 3 μ F. 50V. Elect.
Q513	2211255 or	2SC1815 (GR) or	C506, C507	352741009	10 μ F. 16V. Elect.
	2211256	2SC1815 (BL)	C511-C513	352741009	10 μ F. 16V. Elect.
Q602	2211454 or	2SA1015 (Y) or	C518, C519	352750479	4. 7 μ F. 25V. Elect.
	2212124	2SA1048 (Y)	C520	352741009	10 μ F. 16V. Elect.
Q907	2201035 or	2SD325 (E) or	C521	352732209	22 μ F. 10V. Elect.
	2201074	2SD880 (Y)	C522	352733309	33 μ F. 10V. Elect.
	Diodes		C526	352741009	10 μ F. 16V. Elect.
D201-D206	223105.	1S1555.	C603	352741008	10 μ F. 16V. Elect.
D403-D412	223133 or	DS442X	C604	352780339	3. 3 μ F. 50V. Elect.
	223145	1S2076TD	C605	352780109	1 μ F. 50V. Elect.
D401, D402	223132 or	1K60 or	C901-C903	352752229	2. 200 μ F. 25V. Elect.
D502-D505	223103	1N60	C904	3504168	13. 000 μ F. 25V. Elect.
D601, D621	223105.	1S1555.	C909, C910	352741019	100 μ F. 16V. Elect.
D622	223133 or	DS442X or	C912	352734709	47 μ F. 10V. Elect.
	223145	1S2076TD	C950, C953	352742219	220 μ F. 16V. Elect.
D623	2239673.	RD15EB3.	C951	352744709	47 μ F. 16V. Elect.
	2239691.	RD16EB1.	C952	352742209	22 μ F. 16V. Elect.
	2241152 or	GZA15Y or.			
	2241153	GZA15Z			
△D901, D902	223868	2WD2			
D903	223848	GP08B			
D907	2239491 or	RD6. 2EB1 or			
	2240953	GZA5. 6Z			
	Coils				
L101, L102	223146	NCH4021			
L103, L104	233245	NMC2029			
L201, L202	233221	NMC5021			
L203, L204	233245	NMC2029			
L301, L302	24606069	NCH1007			
L303, L304	24606070	NCH1008			
L305, L306	233194	NCH1039			
L307, L308	233186	NCH3032			
L309-L311	231025	NCH1064			
	Ose. Block				
Z001	24606155	NOB025			
	Capacitors				
C103, C104	392880337	3. 3 μ F. 50V. LL			
C109, C110	352732209	22 μ F. 10V. Elect.			
C111, C112	352741009	10 μ F. 16V. Elect.			
C121-C124	352741009	10 μ F. 16V. Elect.			
C125, C126	352731019	100 μ F. 10V. Elect.			
C135, C136	392841007	10 μ F. 16V. LL			
C137, C138	3-2750479	4. 7 μ F. 25V. Elect.			
C139-C142	352781599	0. 15 μ F. 50V. Elect.			
C143-C146	352784799	0. 47 μ F. 50V. Elect.			
C155, C156	392841007	10 μ F. 16V. LL			
C161, C162	352750479	4. 7 μ F. 25V. Elect.			
C163, C164	352781599	0. 15 μ F. 50V. Elect.			
C165, C166	352784799	0. 47 μ F. 50V. Elect.			
C167, C168	352732219	220 μ F. 10V. Elect.			

Resistors				
R123, R124	5215046	N08HR50KBC, Semi-fixed	PL201-PL205	210147
R221, R222	5104115	N16RKM50KA35F, Input level adjustment variable		IC
R311, R312	5148089	N16RGL10KB35, Output level adjustment variable	Q902	222780120
R321, R322	5215044	N08HR5KBC, Semi-fixed	Q901	2201340 or 2201350
R355, R356	5215046	N08HR50KBC, Semi-fixed	Q905	2211455 or 2212125
R359	441523914	390ohm, 1/2W, Metal oxide film	Q906	2201244
R362	5104142	N12RLS5KB35, ACCU BIAS adjustment variable	D904	Diodes 2239653 or 2241132
R415	5215045	N08HR10KBC, Semi-fixed	D906	223105, 223133 or 223145
R508	5215047	N08HR100KBC, Semi-fixed	C905	352742219
R509	5215046	N08HR50KBC, Semi-fixed	C906	352744709
R534	5215045	N08HR10KBC, Semi-fixed	C907	352783399
△R901	441522294	0.22ohm, 1/2W, Metal oxides film	C913	352781099
S101	25035383	NPS-362-L347, Tape selector	△R902, R903	441520104
S501	25030232	NRS-142-20SS, Accu bias		Resistors
P101, P102	25055045	NPLG-4P33		Radiator
P103	25055038	NPLG-2P29		27160075A
P401	25055047	NPLG-12P35		Screws
P201	25045120	NPJ4PDBL49, Input/output		831430088
P202	25050064	NSCT-4P-S, DIN		Spacers
P402	25050141	NJPS-4P-S		223019
P403	25050142	NJPS-5P-S		Bush
P404	25050144	NJPS-7P-S		223017
Q301	222652	M5218L		
C301, C302	352741009	10μF, 16V. Elect.		
C956	352741019	100μF, 16V. Elect.		
S201, S301	25035384	NPS-162-322-L246		
	Lamps			
	Switches			
	Plugs			
	Terminals			
	Sockets			
	IC			
	Capacitors			
	Diodes			
	Transistors			
	Resistors			
	Capacitors			
	Diodes			
	Transistors			
	Resistors			
	Capacitors			
	Diodes			
	Transistors			
	Resistors			
	Capacitors			
	Diodes			
	Transistors			
	Resistors			
	Capacitors			
	Diodes			
	Transistors			
	Resistors			
	Capacitors			
	Diodes			
	Transistors			
	Resistors			
	Capacitors			
	Diodes			
	Transistors			
	Resistors			
	Capacitors			
	Diodes			
	Transistors			
	Resistors			
	Capacitors			
	Diodes			
	Transistors			
	Resistors			
	Capacitors			
	Diodes			
	Transistors			
	Resistors			
	Capacitors			
	Diodes			
	Transistors			
	Resistors			
	Capacitors			
	Diodes			
	Transistors			
	Resistors			
	Capacitors			
	Diodes			
	Transistors			
	Resistors			
	Capacitors			
	Diodes			
	Transistors			
	Resistors			
	Capacitors			
	Diodes			
	Transistors			
	Resistors			
	Capacitors			
	Diodes			
	Transistors			
	Resistors			
	Capacitors			
	Diodes			
	Transistors			
	Resistors			
	Capacitors			
	Diodes			
	Transistors			
	Resistors			
	Capacitors			
	Diodes			
	Transistors			
	Resistors			
	Capacitors			
	Diodes			
	Transistors			
	Resistors			
	Capacitors			
	Diodes			
	Transistors			
	Resistors			
	Capacitors			
	Diodes			
	Transistors			
	Resistors			
	Capacitors			
	Diodes			
	Transistors			
	Resistors			
	Capacitors			
	Diodes			
	Transistors			
	Resistors			
	Capacitors			
	Diodes			
	Transistors			
	Resistors			
	Capacitors			
	Diodes			
	Transistors			
	Resistors			
	Capacitors			
	Diodes			
	Transistors			
	Resistors			
	Capacitors			
	Diodes			
	Transistors			
	Resistors			
	Capacitors			
	Diodes			
	Transistors			
	Resistors			
	Capacitors			
	Diodes			
	Transistors			
	Resistors			
	Capacitors			
	Diodes			
	Transistors			
	Resistors			
	Capacitors			
	Diodes			
	Transistors			
	Resistors			
	Capacitors			
	Diodes			
	Transistors			
	Resistors			
	Capacitors			
	Diodes			
	Transistors			
	Resistors			
	Capacitors			
	Diodes			
	Transistors			
	Resistors			
	Capacitors			
	Diodes			
	Transistors			
	Resistors			
	Capacitors			
	Diodes			
	Transistors			
	Resistors			
	Capacitors			
	Diodes			
	Transistors			
	Resistors			
	Capacitors			
	Diodes			
	Transistors			
	Resistors			
	Capacitors			
	Diodes			
	Transistors			
	Resistors			
	Capacitors			
	Diodes			
	Transistors			
	Resistors			
	Capacitors			
	Diodes			
	Transistors			
	Resistors			
	Capacitors			
	Diodes			
	Transistors			
	Resistors			
	Capacitors			
	Diodes			
	Transistors			
	Resistors			
	Capacitors			
	Diodes			
	Transistors			
	Resistors			
	Capacitors			
	Diodes			
	Transistors			
	Resistors			
	Capacitors			
	Diodes			
	Transistors			
	Resistors			
	Capacitors			
	Diodes			
	Transistors			
	Resistors			
	Capacitors			
	Diodes			
	Transistors			
	Resistors			
	Capacitors			
	Diodes			
	Transistors			
	Resistors			
	Capacitors			
	Diodes			
	Transistors			
	Resistors			
	Capacitors			
	Diodes			
	Transistors			
	Resistors			
	Capacitors			
	Diodes			
	Transistors			
	Resistors			
	Capacitors			
	Diodes			
	Transistors			
	Resistors			
	Capacitors			
	Diodes			
	Transistors			
	Resistors			
	Capacitors			
	Diodes			
	Transistors			
	Resistors			
	Capacitors			
	Diodes			
	Transistors			
	Resistors			
	Capacitors			
	Diodes			
	Transistors			
	Resistors			
	Capacitors			
	Diodes			
	Transistors			
	Resistors			
	Capacitors			
	Diodes			
	Transistors			
	Resistors			
	Capacitors			
	Diodes			
	Transistors			
	Resistors			
	Capacitors			
	Diodes			
	Transistors			
	Resistors			
	Capacitors			
	Diodes			
	Transistors			
	Resistors			
	Capacitors			
	Diodes			
	Transistors			
	Resistors			
	Capacitors			
	Diodes			
	Transistors			
	Resistors			
	Capacitors			
	Diodes			
	Transistors			
	Resistors			
	Capacitors			
	Diodes			
	Transistors			
	Resistors			
	Capacitors			
	Diodes			
	Transistors			
	Resistors			
	Capacitors			
	Diodes			
	Transistors			
	Resistors			
	Capacitors			
	Diodes			
	Transistors			
	Resistors			
	Capacitors			
	Diodes			
	Transistors			
	Resistors			
	Capacitors			
	Diodes			
	Transistors			
	Resistors			

